



# FERRI®

# Construction



SIMPLY. THE MOWER

Gamma di testate, trinciatrici e decespugliatrici idrauliche per la manutenzione del verde e delle aree boschive per applicazioni a macchine movimento terra.

*Range of flail heads, bush cutters and hydraulic reach mowers for maintenance of green and wooded areas, for construction equipment applications.*



THME



THLD



THM



TIR



TSKID



TSKQ



THFB



THFS



THFL



THFM



THFP



TST



SIMPLY. THE MOWER



Certified ISO 9001

### 180 anni di storia

Dal 1844 e da sei generazioni, Ferri è sinonimo di innovazione tecnologica. Un'evoluzione ottenuta puntando sempre su ricerca e sviluppo di macchine per la manutenzione del verde pubblico e agricolo.

Oggi la Ferri con una produzione e vendita di oltre 35.000 macchine in tutto il mondo, si colloca tra le aziende leader del settore in Europa.

### La sicurezza e la qualità per il nostro futuro

Lo spirito innovativo che ha caratterizzato, da sempre, la progettazione e la produzione dei prodotti della Ferri si è sempre basato su concetti semplici ma efficaci, miglioramento del comfort dell'operatore che significa maggiore sicurezza, fare tesoro dei suggerimenti di chi lavora tutti i giorni con i prodotti Ferri, ricerca costante della migliore qualità sul mercato stringendo collaborazioni strategiche, di lungo termine, con i migliori fornitori nazionali ed internazionali.

Tutto questo in sintesi è alla base dell'ultimo nato in casa Ferri, il **porta-attrezzi radiocomandato iCUT 3.60**, progettato in collaborazione con studi tecnici all'avanguardia, non solo nel settore agricolo, che ha come obiettivo, offrire una valida alternativa, in totale sicurezza, a chi è chiamato ad operare in condizioni difficilmente praticabili con i mezzi tradizionali.

La stessa linea guida che ha permesso di ottenere nel corso del 2016 il prestigioso marchio di **UnimogPartner by Mercedes-Benz**, grazie allo sviluppo di un modello Ferri dedicato per risolvere specifiche esigenze operative della gamma Unimog.

**Ferri, il futuro premia chi crede nel futuro.**

### 180 years of history

*Since 1844 and for six generations, Ferri has been synonymous with Technological Innovation. This evolution has been achieved through continuous focus on the research and development of machines for the maintenance of public and agricultural greenery.*

*Today, Ferri is one of the industry's leading companies in Europe with production and sales of more than 35,000 machines worldwide.*











### Safety and quality for our future





*The innovative spirit that has always characterised the design and production of Ferri products has always been based on simple yet effective concepts, such as improved operator comfort for greater safety, making the most of suggestions from those who work with Ferri products on a daily basis, consistently seeking the best quality on the market and solidifying long-term strategic partnerships with the best national and international suppliers.*

*All of this underpins the latest Ferri product, the **iCUT 3.60 remote controlled carrier machine**, designed in conjunction with state-of-the-art technical studies, not just in the agricultural sector, which aims to provide a viable and completely safe alternative for those operating in difficult conditions with traditional means.*

*The same guideline has allowed us to attain the prestigious **UnimogPartner by Mercedes-Benz** brand in 2016, thanks to the development of a Ferri model designed for the specific operating needs of the Unimog. range.*

**Ferri, the future rewards those who believe in the future.**

Mod.	min  max		Utensili di taglio / Cutting flails			Pag.
	m	ft				
THME	0,60 - 0,80	1.9 - 2.6		-	-	4
THLD	0,85 - 1,05	2.8 - 3.4			-	5
THM	1,05 - 1,25	3.4 - 4.1				6
TIR	1,45	4.7				7

Mod.	min  max		min HP max	Utensili di taglio / Cutting flails			Pag.
	m	ft					
TSKID	1,80 - 2,00	5.9 - 6.5	55 ÷ 95		-	-	8
TSKQ/F	1,60 - 1,80	5.3 - 5.9	70 ÷ 120		-	-	10
TSKQ/A 	1,60 - 1,80	5.3 - 5.9	70 ÷ 120		-	-	12



**FERRI**

SIMPLY. THE MOWER

**THME**

1500 ÷ 3000 Kg

3300 ÷ 6600 lb



16 ÷ 28 lt./min

3.51 ÷ 6.15 gal/min



Ø max 2 cm

Ø max 0.79 in

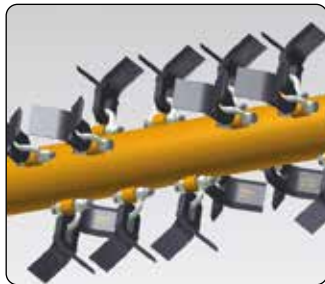
**TESTATE TRINCIANTI IDRAULICHE PER MINIESCAVATORI  
FLAIL HEADS FOR MINI-EXCAVATORS****Dotazione standard**

- Telaio modificato con rinforzi interni ed esterni.
- Controtelaio interno con controcoltelli.
- Dispositivo autolivellante a parallelogramma, escludibile meccanicamente.
- Valvola di massima ed anticavitazione.
- Tubi idraulici con raccorderia protetti da spirale - mt. 1,50 (esclusi innesti terminali).
- Motore QR, fino a 20 bar di contropressione sullo scarico.
- Motore idraulico ad ingranaggi.
- Trasmissione diretta al rotore.
- Carter protezione motore.
- Rullo di appoggio regolabile in altezza.
- Slitte di appoggio con pattini anti-usura sostituibili.
- Protezioni in gommata antiabrasione.

**Accessori**

- Kit drenaggio esterno.
- Kit valvola regolatrice in acciaio tarata completa di tubi di collegamento motore per portate fino a 90 litri con prioritaria a 60 litri.
- Orecchie d'attacco a disegno con perni Ø mm 30/35/40
- Kit tubi idraulici con raccorderia protetti da spirale protettiva mt. 2,3.

**Standard**

- Frame with internal and external reinforcements.
- Internal counter frame with counter knives.
- Self-leveling parallelogram device, mechanically lockable.
- Pressure relief and anti-cavitation valve.
- Hydraulic pipes with fittings protected by spiral - mt. 1.50 (excluding terminal couplings).
- QR motor, up to 20 bar of back pressure on the discharge.
- Hydraulic gear motor.
- Direct transmission to the rotor.
- Motor protection guard.
- Height-adjustable rear roller.
- Adjustable skids with replaceable wear proof plates.
- Protection with abrasion-proof rubberized front protections.

**Accessories**

- External drainage kit.
- Calibrated steel adjusting valve for capacities up to 90 litres with 60 litres priority valve, connecting pipes included.
- Dedicated attachment linkage pins Ø mm 30/35/40.
- Hydraulic pipes kit and connections protected by spiral m 2,3 length.



**QR motor**  
# 1 in the market  
for back pressure  
protection  
**20 Bar**

**INFORMAZIONI TECNICHE - TECHNICAL DATA**

Mod.										
	m.	ft	m.	ft	kg *	lb *	lt min/max	gal min/max	Max. bar	n.
<b>THME 60</b>	0,60	1.96	0,83	2.72	118	260	16 ÷ 48	3.52 ÷ 10.56	200	32
<b>THME 80</b>	0,80	2.62	1,03	3.38	134	295	16 ÷ 48	3.52 ÷ 10.56	200	40

\* Attacco escluso - Linkage not included

**UTENSILI DA TAGLIO - CUTTING FLAILS**

Intercambiabili sullo stesso rotore Interchangeable on the same rotor	<b>THME 60</b>	<b>THME 80</b>			
	Nr. - No	Nr. - No	Ø cm	Ø in	
Coltelli snodati per: erba e cespugli Articulated "Y" flails for: grass, bushes		32	40	2	0,79



3000 ÷ 5500 Kg  
6600 ÷ 12125 lb



28 ÷ 48 lt./min  
6.15 ÷ 10.55 gal/min



Ø max 4 cm  
Ø max 1.57 in

# THLD

# Construction

TESTATE TRINCIANTI IDRAULICHE PER MINIESCAVATORI  
FLAIL HEADS FOR MINI-EXCAVATORS



**QR motor**  
# 1 in the market  
for back pressure  
protection  
**20 Bar**



### Dotazione standard

- Telaio modificato con rinforzi interni ed esterni.
- Controtelaio interno con controcoltelli.
- Dispositivo autolivellante a parallelogramma, escludibile meccanicamente.
- Valvola di massima ed anticavitazione.
- Tubi idraulici con raccorderia protetti da spirale - mt. 1,50 (esclusi innesti terminali).
- Motore QR, fino a 20 bar di contropressione sullo scarico.
- Motore idraulico ad ingranaggi.
- Trasmissione diretta al rotore.
- Carter protezione motore.
- Rullo di appoggio regolabile in altezza.
- Slitte di appoggio con pattini anti-usura sostituibili.
- Protezioni in gommata antiabrasione.

### Accessori

- Kit drenaggio esterno.
- Kit valvola regolatrice in acciaio tarata completa di tubi di collegamento motore per portate fino a 90 litri con prioritaria a 60 litri.
- Orecchie d'attacco a disegno con perni Ø mm 30/35/40
- Kit tubi idraulici con raccorderia protetti da spirale protettiva mt. 2,3.

### Standard

- Frame with internal and external reinforcements.
- Internal counter frame with counter knives.
- Self-leveling parallelogram device, mechanically lockable.
- Pressure relief and anti-cavitation valve.
- Hydraulic pipes with fittings protected by spiral - mt. 1.50 (excluding terminal couplings).
- QR motor, up to 20 bar of back pressure on the discharge.
- Hydraulic gear motor.
- Direct transmission to the rotor.
- Motor protection guard.
- Height-adjustable rear roller.
- Adjustable skids with replaceable wear proof plates.
- Protection with abrasion-proof rubberized front protections.

### Accessories

- External drainage kit.
- Calibrated steel adjusting valve for capacities up to 90 litres with 60 litres priority valve, connecting pipes included.
- Dedicated attachment linkage pins Ø mm 30/35/40.
- Hydraulic pipes kit and connections protected by spiral m 2,3 length.



### INFORMAZIONI TECNICHE - TECHNICAL DATA

Mod.											
	m.	ft	m.	ft	kg *	lb *	lt min/max	gal min/max	Max. bar	n.	n.
<b>THLD 85</b>	0,85	2.79	1,12	3.67	173	381	28 ÷ 48	6.16 ÷ 10.56	200	24 + 12	12
<b>THLD 105</b>	1,05	3.44	1,32	4.33	192	423	28 ÷ 48	6.16 ÷ 10.56	200	32 + 16	16

\* Attacco escluso - Linkage not included

### UTENSILI DA TAGLIO - CUTTING FLAILS

Intercambiabili sullo stesso rotore Interchangeable on the same rotor		THLD 85	THLD 105		
		Nr. - No	Nr. - No	Ø cm	Ø in
Coltelli polivalenti e dritti per: erba, arbusti, cespugli, canne, legna Multiuse and straight blades for: grass, shrubs, bushes, sticks, wood.		24 + 12	32 + 16	3	1.18
Mazze stampate per: legna e arbusti Hammer blades for: wood, shrubs.		12	16	4	1.57

## TESTATE TRINCIANTI IDRAULICHE PER ESCAVATORI FLAIL HEADS FOR EXCAVATORS

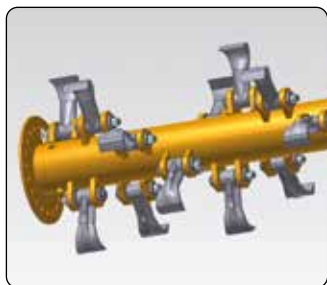

### Dotazione standard

- Telaio con rinforzi interni ed esterni.
- Controtelaio interno con controcoltelli.
- Dispositivo autolivellante a parallelogramma, escludibile meccanicamente.
- Valvola di massima ed anticavitazione.
- Tubi idraulici con raccorderia protetti da spirale - mt. 1,80 (esclusi innesti terminali).
- Motore idraulico ad ingranaggi.
- Trasmissione diretta al rotore.
- Carter protezione motore.
- Rullo di appoggio regolabile in altezza.
- Slitte di appoggio con pattini anti-usura sostituibili.
- Protezioni in gommata antiabrasione.

### Accessori

- Kit drenaggio esterno.
- Kit valvola regolatrice in acciaio tarata completa di tubi di collegamento motore per portate fino a 160 litri con prioritaria a 90 litri.
- Orecchie d'attacco a disegno con perni Ø mm 45/50

### Standard

- Frame with internal and external reinforcements.
- Internal counter frame with counter knives.
- Self-leveling parallelogram device, mechanically lockable.
- Pressure relief and anti-cavitation valve.
- Hydraulic pipes with fittings protected by spiral - mt. 1.80 (excluding terminal couplings).
- Hydraulic gear motor.
- Direct transmission to the rotor.
- Motor protection guard.
- Height-adjustable rear roller.
- Adjustable skids with replaceable wear proof plates.
- Protection with abrasion-proof rubberized front protections.

### Accessories

- External drainage kit.
- Calibrated steel adjusting valve kit for capacities up to 160 litres with 90 litres priority valve.
- Dedicated attachment linkage pins Ø mm 45/50



### INFORMAZIONI TECNICHE - TECHNICAL DATA

Mod.												
	m.	ft	m.	ft	kg *	lb *	lt min/max	gal min/max	Max. bar	n.	n.	n.
<b>THM 105</b>	1,05	3.44	1,29	4.23	333	734	60 ÷ 100	13.20 ÷ 21.99	220	36	18	-
<b>THM 125</b>	1,25	4.10	1,49	1.89	348	767	60 ÷ 100	13.20 ÷ 21.99	220	44	22	18

\* Attacco escluso - Linkage not included

### UTENSILI DA TAGLIO - CUTTING FLAILS

Intercambiabili sullo stesso rotore Interchangeable on the same rotor		THM 105	THM 125		
		Nr. - No	Nr. - No	Ø cm	Ø in
Coltelli polivalenti per: erba, arbusti, cespugli, canne, legna Multiuse blades for grass, bushes, shrubs, sticks, wood		36	44	4	1.57
Mazze stampate per: legna e arbusti Hammer for wood and shrubs		18	22	6	2.36
Martelletti bidirezionali rotanti per legna Turning blades for wood		-	18	8	3.15



10000 ÷ 15000 Kg  
22000 ÷ 33000 lb



90 ÷ 110 lt./min  
19.8 ÷ 24.1 gal/min



Ø max 7 cm  
Ø max 2.75 in

# TIR

# Construction

TESTATE TRINCIANTI IDRAULICHE PER ESCAVATORI  
FLAIL HEADS FOR EXCAVATORS



### Dotazione standard

- Telaio con rinforzi interni ed esterni.
- Controtelaio interno con controcoltelli.
- Valvola di massima ed anticavitazione.
- Tubi idraulici con raccorderia protetti da spirale - mt. 2,20 (esclusi innesti terminali).
- Motore idraulico ad ingranaggi.
- Trasmissione al rotore a cinghie.
- Rullo di appoggio regolabile in altezza.
- Slitte di appoggio con pattini anti-usura sostituibili.
- Protezioni in gommata antiabrasione.
- Protezioni con catene ad alta resistenza.

### Accessori

- Dispositivo autolivellante consigliato per entrambe le versioni.
- Kit valvola regolatrice in acciaio tarata completa di tubi di collegamento motore per portate fino a 160 litri con prioritaria a 90 litri.
- Kit valvola regolatrice in acciaio tarata completa di tubi di collegamento motore per portate fino a 280 litri con prioritaria a 190 litri.
- Ralla di rotazione idraulica 180°, per lavorare nei due sensi di marcia.
- Orecchie d'attacco a disegno con perni Ø mm 50/60

### Standard

- Frame with internal and external reinforcements.
- Internal counter frame with counter knives.
- Pressure relief and anti-cavitation valve.
- Hydraulic pipes with fittings protected by spiral - mt. 2.20 (excluding terminal couplings).
- Hydraulic gear motor.
- Hydraulic piston motor.
- Belt transmission to the rotor.
- Height-adjustable rear roller.
- Adjustable skids with replaceable wear proof plates.
- Protection with high resistance chains.

### Accessories

- Self-leveling kit (cod. AM/R) recommended for both versions.
- Calibrated steel adjusting valve kit, for capacities up to 160 litres with 90 litres priority valve.
- Calibrated steel adjusting valve kit, for capacities up to 280 litres with 190 litres priority valve.
- Hydraulic orientation gear 180°, to work in both directions.
- Dedicated attachment linkage pins Ø mm 50/60



## INFORMAZIONI TECNICHE - TECHNICAL DATA

Mod.													
	m.	ft	m.	ft	kg *	lb *		n.	lt min/max				
<b>TIR 150</b> Motore idraulico ad ingranaggi <i>Gear Hydraulic System</i>	1,45	4,75	1,68	5,51	630	1389	3	90 ÷ 110	19.79 ÷ 21.19	220	48+24	24	24
<b>TIR 150</b> Motore idraulico a pistoni <i>Piston Hydraulic Sys.</i>	1,45	4,75	1,68	5,51	630	1389	3	90 ÷ 110	19.79 ÷ 21.19	270	48+24	24	24

(\* con dispositivo autolivellante, attacco escluso - (\*) With self-leveling kit, linkage not included

## UTENSILI DA TAGLIO - CUTTING FLAILS

Intercambiabili sullo stesso rotore <i>Interchangeable on the same rotor</i>		<b>TIR 150</b>		
		Nr. - No		
Coltelli polivalenti e dritti per: erba, arbusti, cespugli, canne, legna <i>Multise and straight flails for grass, bushes, shrubs, sticks, wood</i>		48+24	5	1.97
Martelli bidirezionali per: legna e arbusti <i>"T" Hammer for: wood</i>		24	7	2.75



Testata trinciante idraulica per lavori su terreni incolti, sottobosco e aree verdi, con erba, cespugli, sarmenti e rovi fino a Ø 4 cm.

Si applica a skid steer loaders e minipale con potenza compresa tra 55 HP e 100 HP e con portata d'olio da 55/12 a 95/21 lt/gal min.

*Hydraulic flail head for works on uncultivated land, underwood and green areas, with grass, bushes, pruning and brambles up to Ø 4 cm.*

*It is applied to skid steer loaders with power ranging between 55 HP and 100 HP and with oil flow from 55/12 to 95/21 liters / gal min.*

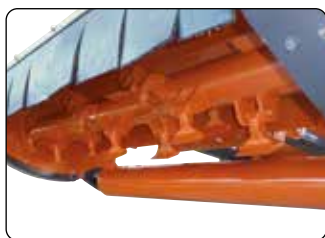

Rotore con mazze stampate.  
Rotor with hammer blades.



Trasmissione a cinghia.  
Belt transmission.



Attacco SAE J2513.  
Universal coupling SAE J2513.



Slitte di appoggio con pattini anti-usura sostituibili.  
Adjustable skids with replaceable wear proof plates.



Scarico del materiale trinciato innanzi al rullo d'appoggio per garantire protezione del guidatore dal materiale trinciato e dalle polveri eventualmente sollevate.  
*The shredded material is discharged before the rear roller to ensure protection to the operator from debris and dust.*



## INFORMAZIONI TECNICHE - TECHNICAL DATA

Mod.	m. ft.		m. ft.		n.	kg lb		lt min/max	gal min/max	Max. bar	n.
<b>TSKID 1800</b>	1,80	5.90	2,07	6.79	4	748	1650	65 ÷ 80	14,29 ÷ 17.59	190 ÷ 210	18
<b>TSKID 2000</b>	2,00	6.56	2,27	7.44	4	780	1720	75 ÷ 95	16.49 ÷ 20.89	190 ÷ 210	20

## UTENSILI DA TAGLIO - CUTTING FLAILS

Intercambiabili sullo stesso rotore  
Interchangeable on the same rotor

Mazze stampate per: legna e arbusti  
Hammer for: wood and shrubs

	TSKID 1800	TSKID 2000		
	Nr. - No	Nr. - No	Ø cm	Ø in
	18	20	4/5	1.57/1.97

### Dotazione standard

- Attacco universale (SAE J2513) con dispositivo autolivellante.
- Telaio rinforzato ad alta resistenza.
- Controtelaio interno con controcoltelli.
- Spostamento meccanico (DX e SX cm. 28).
- Valvola di massima ed anticavitazione.
- Tubi idraulici con raccorderia rotetti da spirale - mt. 3,00 (esclusi innesti terminali).
- Carter protezione motore.
- Motore idraulico bidirezionale ad ingranaggi.
- Trasmissione a 4 cinghie trapezoidali.
- Pulegge intercambiabili per ottimizzare la portata disponibile.
- Rullo di appoggio (diam. mm 168) regolabile in altezza.
- Slitte di appoggio con pattini anti-usura sostituibili.
- Protezioni in gommata antiabrasione.

### Accessori

- Kit valvola regolatrice in acciaio tarata completa di tubi di collegamento motore.
- Spostamento (DX e SX cm 28) a mezzo martinetto idraulico completo di tubi con raccorderia, protetti da spirale (esclusi attacchi rapidi).
- Kit spostamento (DX e SX cm 28) a mezzo martinetto idraulico azionato da elettrovalvola completo di tubi con raccorderia, protetti da spirale (esclusi attacchi rapidi).

### Standard equipment

- Universal coupling (SAE J2513) with self-leveling device.
- High strength reinforced frame.
- Internal counter frame with counter-knives.
- Mechanical shifting (right and left cm. 28).
- Pressure relief and anti-cavitation valve.
- Hydraulic pipes with fittings protected by spiral - mt. 3.00 (excluding terminal couplings)
- Motor protection shaft.
- Bi-directional hydraulic gear motor.
- Belt transmission.
- 4 trapezoidal belts transmission.
- Interchangeable pulleys optimizing available oil flow rate.
- Height-adjustable rear roller (diam 168mm).
- Adjustable skids with replaceable wear proof plates.
- Front protection with abrasion-proof rubberized.

### Accessories:

- Calibrated steel adjusting valve, connecting pipes included.
- Hydraulic side-shift kit (28cm LH and RH) complete with hydraulic hoses and fittings protected by spiral (quick couplings not included).
- Hydraulic side-shift kit (28cm LH and RH) engaged by electro valve, complete with hydraulic hoses and fittings protected by spiral (quick couplings not included).



**TRINCIATRICI IDRAULICHE FORESTALI  
A DENTI FISSI PER MINI PALE  
HYDRAULIC FORESTRY MULCHER  
WITH FIXED TEETH FOR SKID LOADER**



**HARDOX**<sup>®</sup>  
WEAR PLATE

Testata trinciante idraulica forestale a denti fissi per lavori su terreni incolti, aree boschive e aree verdi, con erba, cespugli, sarmenti e rovi fino a Ø 20 cm.

Si applica a skid steer loaders e minipale con potenza compresa tra 70 HP e 120 HP e con portata d'olio da 80/21 a 150/40 lt/gal min.

*Hydraulic forestry flail head with fixed teeth for work on uncultivated land, wooded areas and green areas, with grass, bushes, weeds and brambles up to Ø 20 cm. It is applied to skid steer loaders with power ranging between 70 HP and 120 HP and with oil flow from 80/21 to 150/40 liters/gal min.*



Rotore a denti fissi con riporti al tungsteno.  
Rotor, fixed teeth with tungsten coating and rotor with steel profiles.



Trasmissione a cinghia.  
Belt transmission.



Attacco SAE J2513.  
Universal coupling SAE J2513.



Senso di rotazione del rotore, erba/sterpaglie.  
Rotor direction for grass and bushes.

## INFORMAZIONI TECNICHE - TECHNICAL DATA

Mod.											
	m.	ft.	m.	ft.		n.	kg				lb
<b>TSKQ/F 1600</b>	1,60	5.25	1,87	6.14	4	1020	2250	80 ÷ 150	21.13 ÷ 39.63	220 ÷ 270	33
<b>TSKQ/F 1800</b>	1,80	5.91	2,07	6.79	4	1100	2425	80 ÷ 150	21.13 ÷ 39.63	220 ÷ 270	39

## UTENSILI DA TAGLIO - CUTTING FLAILS

Intercambiabili sullo stesso rotore <i>Interchangeable on the same rotor</i>			TSKQ/F 1600	TSKQ/F 1800		
			Nr. - No	Nr. - No	Ø cm	Ø in
Utensili con riporto al tungsteno <i>Tungsten tipped tool</i>			33	39	20	7.88

### Dotazione standard

- Attacco universale (SAE J2513).
- Telaio rinforzato ad alta resistenza in acciaio ad alto limite di snervatura.
- Controtelaio interno in HARDOX con 2 file di controcoltelli.
- Due file di controcoltelli all'interno del telaio.
- Motore a pistoni da 5 cc.
- Valvola anticavitazione integrata nel motore.
- Cuscinetti montati all'interno del rotore.
- Apertura cofano anteriore con martinetto idraulico.
- Slitte laterali regolabili.
- Tubi con lunghezza 1,80 m.

### Accessori

- Abbatti rami meccanico.
- Valvola idraulica completa di cavo elettrico di controllo dalla cabina dell'operatore per il controllo del martinetto apertura cofano.

### Standard equipment

- Universal coupling (SAE J2513).
- High strength reinforced frame in high yield point steel.
- Double skin HARDOX steel frame equipped with two rows of counter-blades.
- Two rows of counter-knives inside the frame.
- 55 cc piston engine.
- Anti-cavitation valve integrated in the motor.
- Bearings mounted inside the rotor.
- Front hood opening with hydraulic ram.
- Adjustable side skids.
- Tubes with a length of 1.8 m.

### Accessories:

- Push over-bar
- Electro-hydraulic valve complete with electric control cable from the operator's cabin for controlling the front cover opening jack.



**TRINCIATRICI IDRAULICHE FORESTALI  
A DENTI FISSI PER MINI PALE  
HYDRAULIC FORESTRY MULCHER  
WITH FIXED TEETH FOR SKID LOADER**



**HARDOX**<sup>®</sup>  
WEAR PLATE

Testata trinciante idraulica forestale a denti fissi per lavori su terreni incolti, aree boschive e aree verdi, con erba, cespugli, sarmenti e rovi fino a Ø 20 cm.

Si applica a skid steer loaders e minipale con potenza compresa tra 70 HP e 120 HP e con portata d'olio da 80/21 a 150/40 lt/gal min.

*Hydraulic forestry flail head with fixed teeth for work on uncultivated land, wooded areas and green areas, with grass, bushes, weeds and brambles up to Ø 20 cm. It is applied to skid steer loaders with power ranging between 70 HP and 120 HP and with oil flow from 80/21 to 150/40 liters/gal min.*



Rotore a denti fissi con riporti al tungsteno.  
*Rotor, fixed teeth with tungsten coating and rotor with steel profiles.*



Trasmissione a cinghia.  
*Belt transmission.*



Attacco SAE J2513.  
*Universal coupling SAE J2513.*



Senso di rotazione del rotore, erba/sterpaglie.  
*Rotor direction for grass and bushes.*

## INFORMAZIONI TECNICHE - TECHNICAL DATA

Mod.											
	m.	ft.	m.	ft.		n.	kg				lb
<b>TSKQ/A 1600</b>	1,60	5.25	1,87	6.14	4	1020	2250	80 ÷ 150	21.13 ÷ 39.63	220 ÷ 270	33
<b>TSKQ/A 1800</b>	1,80	5.91	2,07	6.79	4	1100	2425	80 ÷ 150	21.13 ÷ 39.63	220 ÷ 270	39

## UTENSILI DA TAGLIO - CUTTING FLAILS

Intercambiabili sullo stesso rotore <i>Interchangeable on the same rotor</i>			<b>TSKQ/A 1600</b>	<b>TSKQ/A 1800</b>		
			Nr. - No	Nr. - No	Ø cm	Ø in
Utensili con riporto al tungsteno <i>Tungsten tipped tool</i>			33	39	20	7.88

### Dotazione standard

- Attacco universale (SAE J2513).
- Telaio rinforzato ad alta resistenza in acciaio ad alto limite di snervatura.
- Controtelaio interno in HARDOX con 2 file di controcoltelli.
- Due file di controcoltelli all'interno del telaio.
- Motore a pistoni da 5 cc.
- Valvola anticavitazione integrata nel motore.
- Cuscinetti montati all'interno del rotore.
- Apertura cofano anteriore con martinetto idraulico.
- Slitte laterali regolabili.
- Tubi con lunghezza 1,80 m.

### Accessori

- Abbatti rami meccanico.
- Valvola idraulica completa di cavo elettrico di controllo dalla cabina dell'operatore per il controllo del martinetto apertura cofano.

### Standard equipment

- Universal coupling (SAE J2513).
- High strength reinforced frame in high yield point steel.
- Double skin HARDOX steel frame equipped with two rows of counter-blades.
- Two rows of counter-knives inside the frame.
- 55 cc piston engine.
- Anti-cavitation valve integrated in the motor.
- Bearings mounted inside the rotor.
- Front hood opening with hydraulic ram.
- Adjustable side skids.
- Tubes with a length of 1.8 m.

### Accessories:

- Push over-bar
- Electro-hydraulic valve complete with electric control cable from the operator's cabin for controlling the front cover opening jack.



## NUOVI ROTORI DENTI FISSI CON RINFORZI AL TUNGSTENO NEW FIXED TEETH ROTORS WITH TUNGSTEN REINFORCEMENTS

### ROTORE APEIRON APEIRON ROTOR

denti fissi con riporti al tungsteno  
e rotore con profili in acciaio.  
*fixed tooth with tungsten coating  
and rotor with steel profiles.*

### ROTORE ROTOR

con utensili fissi.  
*with fixed tooth.*

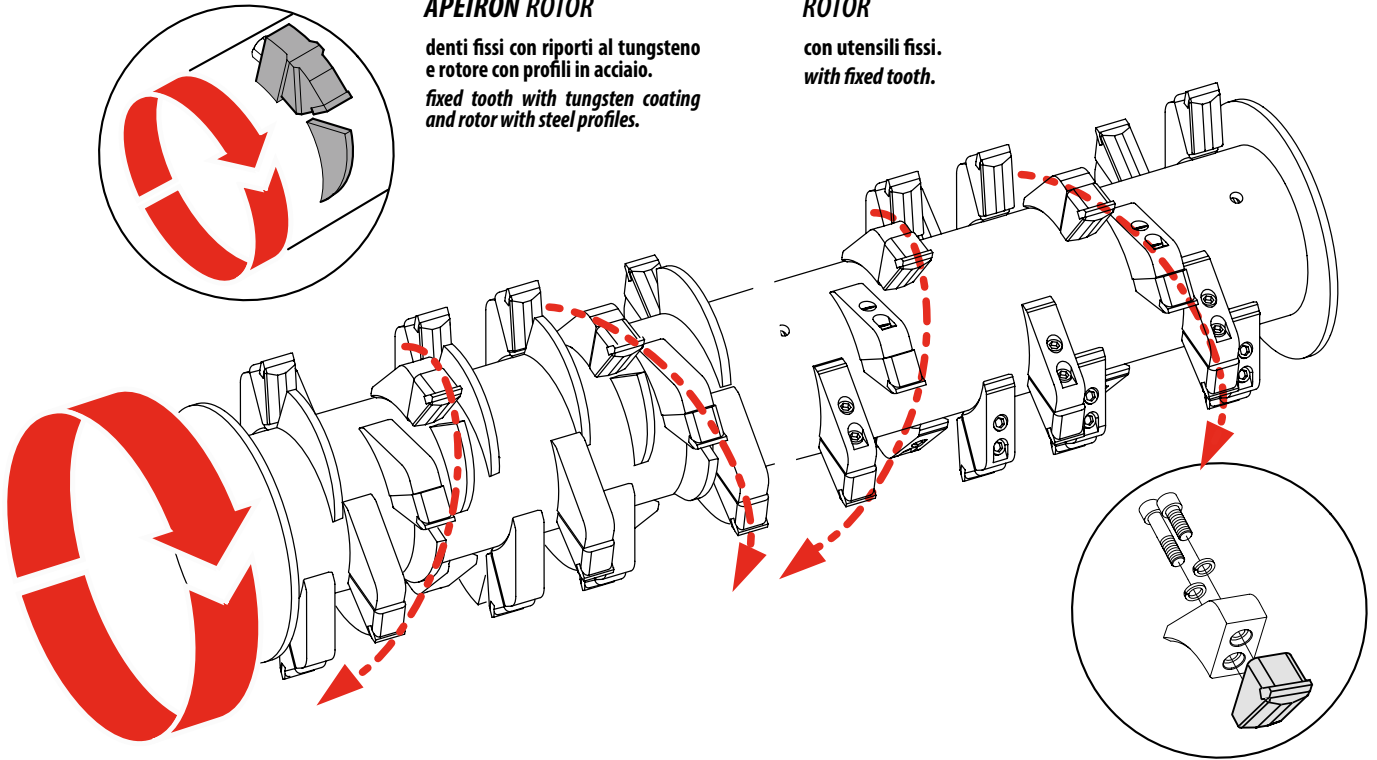

ROTORE APEIRON / APEIRON ROTOR

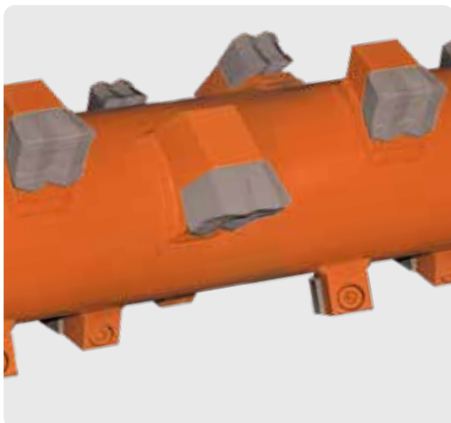

ROTORE / ROTOR

Nuovo Rotore Apeiron Il nuovo rotore Apeiron unisce i vantaggi del rotore a denti fissi agli enormi vantaggi derivanti dalla presenza di particolari profili in HARDOX saldati sequenzialmente sul rotore ed allineati ai supporti dei denti, che per la loro posizione e forma garantiscono una graduale penetrazione dei denti fissi nel materiale da trinciare garantendo uno sforzo omogeneo all'impianto idraulico dell'escavatore.













Disponibilità di nuovi motori.

Su richiesta sono disponibili nuovi motori a cilindrata variabile.

*The new Apeiron rotor combines the advantages of the fixed tooth rotor to the enormous advantages deriving from the presence of Hardox profiles welded sequentially on the rotor and aligned with the tooth supports, that for their position and shape guarantee a gradual penetration of the fixed teeth into the material to be chopped guaranteeing a homogeneous effort to the hydraulic system of the excavator. Increased productivity and lower fuel consumption.*

*New engines available.*

*New variable displacement engines are available on request.*

Mod.	min  max		Utensili di taglio / Cutting flails			Pagina Page
	m	ft				
THFB/A	0,70 - 0,90	2.30 - 2.95		-	-	14
THFS/R	0,80 - 1,00	2.62 - 3.28		-	-	15
THFS/A	0,80 - 1,00	2.62 - 3.28		-	-	16
THFL/R	1,05 - 1,30	3.44 - 4.26		-	-	17
THFL/A	1,05 - 1,30	3.44 - 4.26		-	-	18
THFM/F	1,30 - 1,60	4.27 - 5.24		-	-	19
THFM/A	1,30 - 1,60	4.26 - 5.24		-	-	20
THFP/F	1,30 - 1,60	4.26 - 5.24		-	-	21
THFP/A	1,30 - 1,60	4.26 - 5.24		-	-	22
TST	1,20	3.94			-	24



# FERRI

SIMPLY. THE MOWER

# THFB/A

3.500 ÷ 6.000 Kg  
7.700 ÷ 13.200 lb



22 ÷ 40 lt/min  
4.8 ÷ 8.8 gal/min



Ø max 10 cm  
Ø max 3.93 in



## TESTATE TRINCIANTI IDRAULICHE FORESTALI PER MINI ESCAVATORI FORESTRY FLAIL HEADS FOR MINI-EXCAVATORS



**Rotore Apeiron, denti fissi con riporti al tungsteno e rotore con profili in acciaio.**

**Apeiron rotor, fixed tools with tungsten coating and rotor with steel profiles.**

### Dotazione standard

- Piastra in acciaio per costruire la sella di attacco.
- Struttura con controtelaio interno in DOMEX.
- Motori a pistoni da 12 cc.. (Mod. THFB/A 70).
- Motori a pistoni da 17 cc.. (Mod. THFB/A 90).
- Valvola anticavitazione integrata nel motore.
- Trasmissione a 2 cinghie.
- Cuscinetti montati all'interno del rotore.
- Apertura cofano anteriore con martinetto idraulico.
- Slitte laterali regolabili.
- Tubi con lunghezza 2 m.
- Protezione anteriore con catene ad alta resistenza.
- Protezione posteriore con catene ad alta resistenza a due file.
- Rotore Apeiron.

### Accessori

- Kit valvola Sella di attacco a disegno con perni in acciaio - previo invio dati richiesti
- Valvola elettroidraulica completa di cavo elettrico di controllo dalla cabina dell'operatore per il controllo del martinetto apertura cofano

### Standard

- Steel plate to build the coupling seat.
- Chassis with internal counterframe in DOMEX.
- 12 cc piston motor (Mod. THFB / A 70)
- 17 cc piston moto (Mod. THFB/A 90).
- Anti-cavitation valve integrated in the motor.
- 2 belts transmission.
- Bearings mounted inside rotor.
- Front hood opening with hydraulic ram
- Adjustable side skids.
- Pipes with length 2 m.
- Front protection with high resistanchains.
- Rear protection with high resistance two-rows chains.
- Apeiron rotor.

### Accessories

- Linkage as per drawing with steel pins-subject to forwarding of required data
- Electro-hydraulic valve complete with electric control cable from the operator's cabin for controlling the front cover opening jack











Senso di rotazione del rotore, erba/sterpaglie.  
Rotor direction for grass and bushes.

**Rotore Apeiron e con utensili fissi con inserti al tungsteno  
Apeiron rotor and Tungsten tipped tool**

**DOMEX**<sup>®</sup>  
HIGH STRENGTH STEEL

### INFORMAZIONI TECNICHE - TECHNICAL DATA

Mod.									
	m (ft)	m (ft)	Ø mm (in)	Ø mm (in)	n.	kg *(lb)	lt (gal) min/max	Max. bar	n.
THFB/A70	0,70 (2.30)	0,88 (2.89)	200 (7.87)	360 (14.17)	2	285 (628)	22 ÷ 40 (4.84 ÷ 8.80)	230	27
THFB/A90	0,90 (2.95)	1,08 (3.54)	200 (7.87)	360 (14.17)	2	380 (838)	22 ÷ 40 (4.84 ÷ 8.80)	230	31

\* Attacco escluso / Linkage not included

### UTENSILI DA TAGLIO - CUTTING FLAILS

Con rotore dedicato With dedicated rotor	THFB/A70	THFB/A90		
	Nr. - No	Nr. - No	Ø cm	Ø in
Utensili fissi reversibili con inserti al carburo di tungsteno Tungsten tipped tool	 27	31	10	3.93





5.000 ÷ 9.000 Kg  
11000 ÷ 19800 lb



50 ÷ 90 lt/min  
10.9 ÷ 19.8 gal/min



Ø max 10 cm  
Ø max 3.93 in

# THFS/R

# Construction

TESTATE TRINCIANTI IDRAULICHE FORESTALI PER MIDI ESCAVATORI  
FORESTRY FLAIL HEADS FOR MIDI-EXCAVATORS



Rotore con mazze forgiate bidirezionali  
Rotor with bi-directional forged hammers

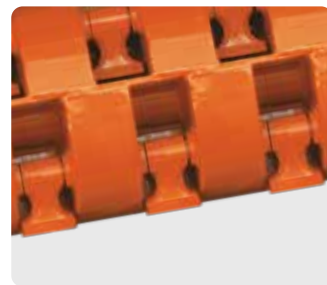

Rotore con mazze forgiate bidirezionali.  
Rotor with bi-directional forged hammers

### Dotazione standard









- Telaio costruito interamente in acciaio ad alto indice di snervamento.
- Martinetto idraulico per apertura cofano.
- Valvola di massima ed anticavitazione.
- Tubi idraulici con raccorderia protetti da spirale (esclusi innesti terminali).
- Carter protezione motore.
- Motore idraulico bidirezionale a pistoni.
- Trasmissione a 3 cinghie trapezoidali.
- Pulegge intercambiabili per ottimizzare la portata disponibile.
- Slitte di appoggio con pattini anti-usura sostituibili.
- Protezione anteriore con catene singole.
- Protezione posteriore con catene ad alta resistenza a due file.

### Accessori

- Kit valvola regolatrice in acciaio tarata completa di tubi di collegamento motore per portare fino a 160 litri con prioritaria a 90 litri • Sella d'attacco a disegno con perni in acciaio - previo invio dati richiesti • Maggiorazione per motore a pistoni 47 cc. • Rullo di appoggio regolabile in altezza



### INFORMAZIONI TECNICHE - TECHNICAL DATA

Mod.									
	m (ft)	m (ft)	Ø mm (in)	Ø mm (in)	n.	kg *(lb)	lt (gal) min/max	Max. bar	n.
THFS/R80	0,80 (2.62)	1,05 (3.44)	245 (9.65)	400 (15.35)	3	380 (837)	50 ÷ 90 (10.99 ÷ 19.79)	250	16
THFS/R100	1,00 (3.28)	1,25 (4.10)	245 (9.65)	400 (15.75)	3	460 (1014)	60 ÷ 90 (13.19 ÷ 19.79)	250	20

\* Attacco escluso / Linkage not included

### UTENSILI DA TAGLIO - CUTTING FLAILS

Con rotore dedicato With dedicated rotor	THFS/R80 Nr. - No	THFS/R100 Nr. - No		Ø cm	Ø in
Mazze forgiate bidirezionali Bidirectional forged hammers	 16	20		10	3.93

### Standard

- High strength steel frame.
- Hydraulic jack for the housing opening.
- Pressure relief and anti-cavitation valve.
- Hydraulic pipes with fittings protected by a spiral (excluding terminal couplings).
- Motor protection shaft.
- Bi-directional hydraulic pistons motor.
- 3 trapezoidal belts transmission.
- Interchangeable pulleys optimizing available oil flow rate.
- Adjustable skids with replaceable wear proof plates.
- Front protection with high resistance chains.
- Rear protection with high resistance two-rows chains.

### Accessories

- Calibrated steel adjusting valve kit for capacities up to 160 litres with 90 litres priority valve
- Linkage as per drawing with steel pins-subject to forwarding of required data • Extra charge for pistons motor 47 cc. • Adjustable rear roller.

# FERRI

SIMPLY. THE MOWER

# THFS/A

5.000 ÷ 9.000 Kg

11.000 ÷ 19.800 lb



50 ÷ 90 lt/min

10.99 ÷ 19.79 gal/



Ø max 15 cm

Ø max 5.91 in



**Rotore Apeiron, denti fissi con riporti al tungsteno e rotore con profili in acciaio.**

**Apeiron rotor, fixed tools with tungsten coating and rotor with steel profiles.**

### Dotazione standard

- Telaio costruito interamente in acciaio HARDOX.
- Martinetto idraulico per apertura cofano.
- Valvola di massima ed anticavitazione.
- Tubi idraulici con raccorderia protetti da spirale (esclusi innesti terminali).
- Carter protezione motore.
- Motore idraulico bidirezionale a pistoni.
- Trasmissione a 3 cinghie trapezoidali.
- Pulegge intercambiabili per ottimizzare la portata disponibile.
- Slitte di appoggio con pattini anti-usura sostituibili.
- Protezione anteriore con catene singole.
- Protezione posteriore con catene ad alta resistenza a due file.
- Rotore Apeiron.

### Accessori

- Kit valvola regolatrice in acciaio tarata completa di tubi di collegamento motore per portate fino a 160 litri con prioritaria a 90 litri • Sella d'attacco a disegno con perni in acciaio - previo invio dati richiesti • Maggiorazione per motore a pistoni 47 cc. • Motore a pistoni VM 28 Bosh-Rexroth a cilindrata variabile • Kit valvola elettroidraulica completa di cavo elettrico di controllo del cilindro apertura sportello • Rullo di appoggio regolabile in altezza

### Standard

- HARDOX High strength steel frame.
- Hydraulic jack for the housing opening.
- Pressure relief and anti-cavitation valve.
- Hydraulic pipes with fittings protected by a spiral (excluding terminal couplings).
- Motor protection shaft.
- Bi-directional hydraulic pistons motor.
- 3 trapezoidal belts transmission.
- Interchangeable pulleys optimizing available oil flow rate.
- Adjustable skids with replaceable wear proof plates.
- Front protection with high resistance chains.
- Rear protection with high resistance two-rows chains.
- Apeiron rotor.

### Accessories

- Calibrated steel adjusting valve kit for capacities up to 160 litres with 90 litres priority valve
- Linkage as per drawing with steel pins-subject to forwarding of required data • Extra charge for pistons motor 47 cc. • VM 28 Bosch-Rexroth piston motor with variable displacement • Electro-hydraulic valve kit complete with electric cable to control the front hood opening cylinder • Adjustable rear roller



**Rotore Apeiron e con utensili fissi con inserti al tungsteno**  
**Apeiron rotor, fixed tools with tungsten coating and rotor with steel profiles**

## HARDOX®

WEAR PLATE



### INFORMAZIONI TECNICHE - TECHNICAL DATA

Mod.									
	m (ft)	m (ft)	Ø mm (in)	Ø mm (in)	n.	kg *(lb)	lt (gal) min/max	Max. bar	n.
THFS/A 80	0,80 (2.62)	1,05 (3.44)	245 (9.64)	400 (15.75)	3	430 (948)	50 ÷ 90 (10.99 ÷ 19.79)	250	18
THFS/A100	1,00 (3.28)	1,25 (4.10)	245 (9.64)	400 (15.75)	3	505 (1113)	50 ÷ 90 (10.99 ÷ 19.79)	250	22

\* Attacco escluso / Linkage not included

### UTENSILI DA TAGLIO - CUTTING FLAILS

Con rotore dedicato With dedicated rotor	THFS/A80 Nr. - No	THFS/A100 Nr. - No		Ø cm	Ø in
Utensili fissi reversibili con inserti al carburo di tungsteno Tungsten tipped tool	18	22		15	5.91



9.000 ÷ 15.000 Kg  
19.800 ÷ 33.000 lb



90 ÷ 100 lt./min  
19.8 ÷ 22.0 gal/min



Ø max 15 cm  
Ø max 5.9 in

# THFL/R

# Construction

**TESTATE TRINCIANTI IDRAULICHE FORESTALI PER MIDI ESCAVATORI**  
**FORESTRY FLAIL HEADS FOR MIDI-EXCAVATORS**



**Rotore con mazze forgiate.**  
**Rotor with forged hammers.**

**HARDOX®**  
WEAR PLATE

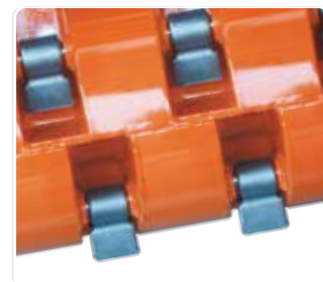

**Rotore con mazze forgiate.**  
**Rotor with forged hammers.**

### Dotazione standard

- Telaio costruito interamente in acciaio DOMEX.
- Controtelaio interno in acciaio HARDOX con 2 controcoltelli in acciaio mm 20 di spessore.
- Martinetto idraulico per apertura cofano.
- Valvola di massima ed anticavitazione.
- Tubi idraulici con raccorderia protetti da spirale (esclusi innesti terminali).
- Carter protezione motore.
- Motore idraulico bidirezionale a pistoni.
- Trasmissione a 5 cinghie trapezoidali.
- Slitte di appoggio con pattini anti-usura sostituibili.
- Protezione anteriore con catene ad alta resistenza.
- Protezione posteriore con catene ad alta resistenza a due file.

### Accessori

- Kit valvola regolatrice in acciaio tarata completa di tubi di collegamento motore per portate fino a 160 litri con prioritaria a 90 litri • Kit valvola regolatrice in acciaio tarata completa di tubi di collegamento motore per portate fino a 280 litri con prioritaria a 190 litri • Sella d'attacco a disegno con perni Ø mm 50/65 - previo invio dati richiesti.

### Standard

- DOMEX steel frame.
- HARDOX steel internal counter frame with 2 counter-knives 20 mm thick steel.
- Hydraulic jack for the housing opening.
- Pressure relief and anti-cavitation valve.
- Hydraulic pipes with fittings protected by a spiral (excluding terminal couplings).
- Motor protection shaft.
- Bi-directional hydraulic pistons motor.
- 5 trapezoidal belts transmission.
- Adjustable skids with replaceable wear proof plates.
- Front protection with high resistance chains.
- Rear protection with high resistance two-rows chains

### Accessories

- Calibrated steel adjusting valve kit for capacities up to 160 litres with 90 litres priority valve • Calibrated steel adjusting valve kit for capacities up to 280 litres with 190 litres priority valve • Dedicated attachment linkage pins Ø mm 50/60 - please send the required data.



### INFORMAZIONI TECNICHE - TECHNICAL DATA

Mod.									
	m (ft)	m (ft)	Ø mm (in)	Ø mm (in)	n.	kg (lb)	lt (gal) min/max	Max. bar	n.
THFL/R 105	1,05 (3.44)	1,40 (4.59)	273 (10.75)	500 (19.69)	5	710 (1565)	90 ÷ 100 (19.79 ÷ 21.99)	250	16
THFL/R 130	1,30 (4.26)	1,65 (5.41)	273 (10.75)	500 (19.69)	5	760 (1676)	90 ÷ 100 (19.79 ÷ 21.99)	250	20

### UTENSILI DA TAGLIO - CUTTING FLAILS

Con rotore dedicato With dedicated rotor		THFL/R 105	THFL/R 130		
		Nr. - No	Nr. - No	Ø cm	Ø in
Mazze forgiate Forged hammers		16	20	15	5,9

## TESTATE TRINCIANTI IDRAULICHE FORESTALI PER MIDI ESCAVATORI FORESTRY FLAIL HEADS FOR MIDI-EXCAVATORS



**Rotore Apeiron, denti fissi con riporti al tungsteno e rotore con profili in acciaio.**

**Apeiron rotor, fixed tools with tungsten coating and rotor with steel profiles.**

### Dotazione standard

- Telaio costruito interamente in acciaio DOMEX.
- Controtelaio interno in acciaio HARDOX con 2 controcoltelli in acciaio mm 20 di spessore.
- Martinetto idraulico per apertura cofano.
- Valvola di massima ed anticavitazione.
- Tubi idraulici con raccorderia protetti da spirale (esclusi innesti terminali).
- Carter protezione motore.
- Motore idraulico bidirezionale a pistoni.
- Trasmissione a 5 cinghie trapezoidali.
- Slitte di appoggio con pattini anti-usura sostituibili.
- Protezione anteriore con catene ad alta resistenza.
- Protezione posteriore con catene ad alta resistenza a due file.
- Tubi con lunghezza 2 m.
- Rotore Apeiron.

### Accessori

• Kit valvola regolatrice in acciaio tarata completa di tubi di collegamento motore per portate fino a 160 litri con prioritaria a 90 litri • Kit valvola regolatrice in acciaio tarata completa di tubi di collegamento motore per portate fino a 280 litri con prioritaria a 190 litri • Sella d'attacco a disegno con perni Ø mm 50/65 - previo invio dati richiesti • Maggiorazione per motore a pistoni 56 cc. • Motore a pistoni VM 55 Bosh-Rexroth a cilindrata variabile • Piede di acciaio per appoggio escavatore • Kit valvola elettroidraulica completa di cavo elettrico di controllo del cilindro apertura sportello

### Standard

- DOMEX steel frame.
- HARDOX steel internal counter frame with 2 counter-knives 20 mm thick steel.
- Hydraulic jack for the housing opening.
- Pressure relief and anti-cavitation valve.
- Hydraulic pipes with fittings protected by a spiral (excluding terminal couplings).
- Motor protection shaft.
- Bi-directional hydraulic pistons motor.
- 5 trapezoidal belts transmission.
- Adjustable skids with replaceable wear proof plates.
- Front protection with high resistance chains.
- Rear protection with high resistance two-rows chains.
- Pipes with length 2 m
- Apeiron rotor.

### Accessories

• Calibrated steel adjusting valve kit for capacities up to 160 litres with 90 litres priority valve • Calibrated steel adjusting valve kit for capacities up to 280 litres with 190 litres priority valve • Dedicated attachment linkage pins Ø mm 50/60 - please send the required data • Extra charge for pistons motor 56 cc. • VM 55 Bosch-Rexroth piston motor with variable displacement • Thumb bracket • Electro-hydraulic valve kit complete with electric cable to control the front hood opening cylinder



**Rotore Apeiron e con utensili fissi con inserti al tungsteno  
Apeiron rotor and with fixed tools and tungsten carbide inserts with steel profiles**

**HARDOX® DOMEX®**  
WEAR PLATE HIGH STRENGTH STEEL



### INFORMAZIONI TECNICHE - TECHNICAL DATA

Mod.									
	m (ft)	m (ft)	Ø mm (in)	Ø mm (in)	n.	kg *(lb)	lt (gal) min/max	Max. bar	n.
THFL/A105	1,05 (3.44)	1,40 (4.59)	273 (10.74)	500 (19.68)	5	745 (1642)	90 ÷ 100 (19.79 ÷ 21.99)	250	22
THFL/A130	1,30 (4.26)	1,65 (5.41)	273 (10.74)	500 (19.68)	5	800 (1764)	90 ÷ 100 (19.79 ÷ 21.99)	250	26

\* Attacco escluso / Linkage not included

### UTENSILI DA TAGLIO - CUTTING FLAILS

Con rotore dedicato With dedicated rotor	THFL/A 105	THFL/A 130			
	Nr. - No	Nr. - No	Ø cm	Ø in	
Utensili fissi con inserti al carburo di tungsteno Fixed tools with tungsten carbide inserts		22	26	18	7.08



12.000 ÷ 21.000 Kg  
26.400 ÷ 46.300 lb



120 ÷ 130 lt./min  
26.4 ÷ 28.6 gal/min



Ø max 30 cm  
Ø max 11.81 in

# THFM/F

# Construction

## TESTATE TRINCIANTI IDRAULICHE FORESTALI PER ESCAVATORI FORESTRY FLAIL HEADS FOR EXCAVATORS



**Rotore con utensili fissi con inserti al carburo di tungsteno**  
*Rotor with fixed tools with tungsten carbide inserts*



**Rotore con utensili fissi.**  
*Rotor with fixed tools.*

### Dotazione standard

- Telaio costruito interamente in acciaio DOMEX.
- Controtelaio interno in acciaio HARDOX con 2 controcoltelli in acciaio mm 20 di spessore.
- Martinetto idraulico per apertura cofano.
- Valvola di massima ed anticavitazione.
- Tubi idraulici con raccorderia protetti da spirale (esclusi innesti terminali).
- Carter protezione motore.
- Motore idraulico bidirezionale a pistoni.
- Trasmissione a 5 cinghie trapezoidali.
- Slitte di appoggio con pattini anti-usura sostituibili.
- Protezione anteriore con catene ad alta resistenza.
- Protezione posteriore con catene ad alta resistenza a due file.

### Accessori

- Kit valvola regolatrice in acciaio tarata completa di tubi di collegamento motore per portate fino a 160 litri con prioritaria a 90 litri
- Kit valvola regolatrice in acciaio tarata completa di tubi di collegamento motore per portate fino a 280 litri con prioritaria a 190 litri
- Orecchie d'attacco a disegno con perni in acciaio

### Standard

- DOMEX steel frame.
- HARDOX steel internal counter frame with 2 counter-knives 20 mm thick steel.
- Hydraulic jack for the housing opening.
- Pressure relief and anti-cavitation valve.
- Hydraulic pipes with fittings protected by a spiral (excluding terminal couplings).
- Motor protection shaft.
- Bi-directional hydraulic pistons motor.
- 5 trapezoidal belts transmission.
- Adjustable skids with replaceable wear proof plates.
- Front protection with high resistance chains.
- Rear protection with high resistance two-rows chains.

### Accessories

- Calibrated steel adjusting valve kit for capacities up to 160 litres with 90 litres priority valve
- Calibrated steel adjusting valve kit for capacities up to 280 litres with 190 litres priority valve
- Dedicated attachment linkage pins Ø mm 50/60

**HARDOX® DOMEX®**  
WEAR PLATE HIGH STRENGTH STEEL



### INFORMAZIONI TECNICHE - TECHNICAL DATA

Mod.									
	m (ft)	m (ft)	Ø mm (in)	Ø mm (in)	n.	kg *(lb)	lt (gal) min/max	Max. bar	n.
THFM/F130	1,30 (4.27)	1,55 (5.09)	273 (10.74)	500 (19.68)	5	990 (2182)	120 ÷ 130 (26.39 ÷ 28.59)	270	26
THFM/F160	1,60 (5.24)	1,85 (6.07)	273 (10.74)	500 (19.68)	5	1120 (2470)	120 ÷ 130 (26.39 ÷ 28.59)	270	30

\* Attacco escluso / Linkage not included

### UTENSILI DA TAGLIO - CUTTING FLAILS

Con rotore dedicato With dedicated rotor		THFM/F 105	THFM/F 130	THFM/F 160		
		Nr. - No	Nr. - No	Nr. - No	Ø cm	Ø in
Utensili fissi con inserti al carburo di tungsteno Fixed tools with tungsten carbide inserts		22	26	30	30	11.81



## TESTATE TRINCIANTI IDRAULICHE FORESTALI PER ESCAVATORI FORESTRY FLAIL HEADS FOR EXCAVATORS



**Rotore Apeiron, denti fissi con riporti al tungsteno e rotore con profili in acciaio.**

**Apeiron rotor, fixed tools with tungsten coating and rotor with steel profiles.**

### Dotazione standard

- Telaio costruito interamente in acciaio DOMEX.
- Controtelaio interno in acciaio HARDOX con 2 controcotelli in acciaio mm 20 di spessore.
- Martinetto idraulico per apertura cofano.
- Valvola di massima ed anticavitazione.
- Tubi idraulici con raccorderia protetti da spirale (esclusi innesti terminali).
- Carter protezione motore.
- Motore idraulico bidirezionale a pistoni.
- Trasmissione a 5 cinghie trapezoidali.
- Slitte di appoggio con pattini anti-usura sostituibili.
- Protezione anteriore con catene ad alta resistenza.
- Protezione posteriore con catene ad alta resistenza a due file.
- Tubi con lunghezza 2,5 m.
- Rotore Apeiron.

### Accessori

- Kit valvola regolatrice in acciaio tarata completa di tubi di collegamento motore per portate fino a 160 litri con prioritaria a 90 litri • Kit valvola regolatrice in acciaio tarata completa di tubi di collegamento motore per portate fino a 280 litri con prioritaria a 190 litri • Sella d'attacco a disegno con perni Ø mm 65 - previo invio dati richiesti • Maggiorazione per motore a pistoni 64 cc. • Motore a pistoni VM 55 Bosh-Rexroth a cilindrata variabile • Piede di acciaio per appoggio escavatore • Kit valvola elettroidraulica completa di cavo elettrico di controllo del cilindro apertura sportello.

### Standard

- DOMEX steel frame.
- HARDOX steel internal counter frame with 2 counter-knives 20 mm thick steel.
- Hydraulic jack for the housing opening.
- Pressure relief and anti-cavitation valve.
- Hydraulic pipes with fittings protected by a spiral (excluding terminal couplings).
- Motor protection shaft.
- Bi-directional hydraulic pistons motor.
- 5 trapezoidal belts transmission.
- Adjustable skids with replaceable wear proof plates.
- Front protection with high resistance chains.
- Rear protection with high resistance two-rows chains.
- Pipes with length 2,5 m
- Apeiron rotor.

### Accessories

- Calibrated steel adjusting valve kit for capacities up to 160 litres with 90 litres priority valve • Calibrated steel adjusting valve kit for capacities up to 280 litres with 190 litres priority valve • Dedicated attachment linkage pins Ø mm 65 - please send the required data • Extra charge for pistons motor 64 cc. • VM 55 Bosh-Rexroth piston motor with variable displacement • Thumb bracket • Electro-hydraulic valve kit complete with electric cable to control the front hood opening cylinder

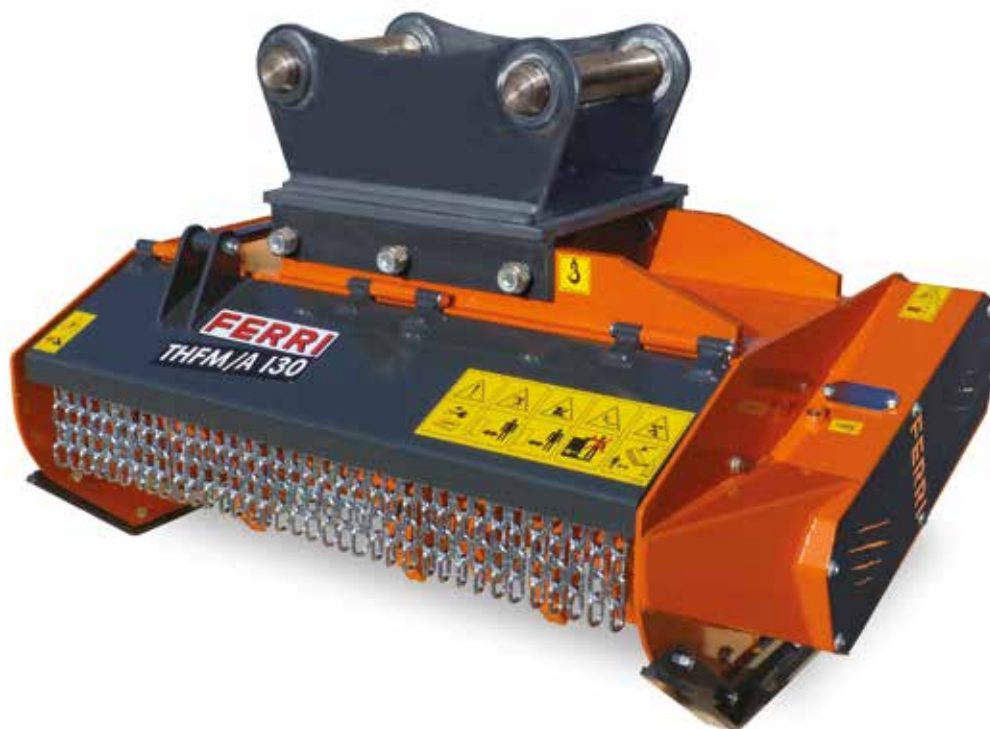

**Rotore Apeiron e con utensili fissi con inserti al tungsteno  
Apeiron rotor and with fixed tools and tungsten carbide inserts with steel profiles**

**HARDOX® DOMEX®**  
WEAR PLATE HIGH STRENGTH STEEL



### INFORMAZIONI TECNICHE - TECHNICAL DATA

Mod.									
	m (ft)	m (ft)	Ø mm (in)	Ø mm (in)	n.	kg *(lb)	lt (gal) min/max	Max. bar	n.
THFM/A130	1,30 (4.26)	1,55 (5.09)	273 (10.74)	500 (19.68)	5	1020 (2249)	120 ÷ 130 (26.39 ÷ 28.59)	270	26
THFM/A160	1,60 (5.24)	1,85 (6.07)	273 (10.74)	500 (19.68)	5	1160 (2558)	120 ÷ 130 (26.39 ÷ 28.59)	270	30

\* Attacco escluso / Linkage not included

### UTENSILI DA TAGLIO - CUTTING FLAILS

Con rotore dedicato With dedicated rotor	THFM/A 130	THFM/A 160		
	Nr. - No	Nr. - No	Ø cm	Ø in
Utensili fissi con inserti al carburo di tungsteno Fixed tools with tungsten carbide inserts	26	30	30	11.81

> 20.000 Kg  
> 44.000 lb



170 ÷ 180 lt./min  
37.4 ÷ 39.6 gal/min



Ø max 40 cm  
Ø max 15.74 in

# THFP/F

# Construction

**TESTATE TRINCIANTI IDRAULICHE FORESTALI PER ESCAVATORI**  
**FORESTRY FLAIL HEADS FOR EXCAVATORS**



**Rotore con utensili fissi con inserti al carburo di tungsteno**  
*Rotor with fixed tools*



**Rotore con utensili fissi.**  
*Rotor with fixed tools.*

### Dotazione standard

- Telaio costruito interamente in acciaio DOMEX.
- Controtelaio interno in acciaio HARDOX con 2 controcoltelli in acciaio mm 20 di spessore.
- Martinetto idraulico per apertura cofano.
- Valvola di massima ed anticavitazione.
- Tubi idraulici con raccorderia protetti da spirale (esclusi innesti terminali).
- Carter protezione motore.
- Motore idraulico bidirezionale a pistoni.
- Trasmissione a 5 cinghie trapezoidali.
- Slitte di appoggio con pattini anti-usura sostituibili.
- Protezione posteriore con catene ad alta resistenza a due file.

### Accessori

- Kit valvola regolatrice in acciaio tarata completa di tubi di collegamento motore per portate fino a 280 litri con prioritaria a 190 litri • Sella d'attacco a disegno con perni Ø mm 70/80 - previo invio dati richiesti

**HARDOX® DOMEX®**  
WEAR PLATE HIGH STRENGTH STEEL



### INFORMAZIONI TECNICHE - TECHNICAL DATA

Mod.									
	m (ft)	m (ft)	Ø mm (in)	Ø mm (in)	n.	kg *(lb)	lt (gal) min/max	Max. bar	n.
THFP/F130	1,30 (4.26)	1,65 (5.41)	273 (10.74)	500 (19.68)	5	1380 (3042)	170 ÷ 180 (37.39 ÷ 39.59)	330	26
THFP/F160	1,60 (5.24)	1,95 (6.39)	273 (10.74)	500 (19.68)	5	1560 (3439)	170 ÷ 180 (37.39 ÷ 39.59)	330	30

\* Attacco escluso / Linkage not included

### UTENSILI DA TAGLIO - CUTTING FLAILS

Con rotore dedicato <i>With dedicated rotor</i>		THFP/F 130	THFP/F 160		
		Nr. - No	Nr. - No	Ø cm	Ø in
Utensili fissi con inserti al carburo di tungsteno <i>Fixed tools with tungsten carbide inserts</i>		26	30	40	15.74

### Standard

- DOMEX steel frame.
- HARDOX steel internal counter frame with 2 counter-knives 20 mm thick steel.
- Hydraulic jack for the housing opening.
- Pressure relief and anti-cavitation valve.
- Hydraulic pipes with fittings protected by a spiral (excluding terminal couplings).
- Motor protection shaft.
- Bi-directional hydraulic pistons motor.
- 5 trapezoidal belts transmission.
- Adjustable skids with replaceable wear proof plates.
- Rear protection with high resistance two-rows chains.

### Accessories

- Calibrated steel adjusting valve kit for capacities up to 280 litres with 190 litres priority valve • Dedicated attachment linkage pins Ø mm 70/80

# FERRI

SIMPLY. THE MOWER

# THFP/A

> 20.000 Kg  
> 44.000 lb

170 ÷ 180 lt./min  
37.4 ÷ 39.6 gal/min

Ø max 40 cm  
Ø max 15.74 in



**Rotore Apeiron, denti fissi con riporti al tungsteno e rotore con profili in acciaio.**

**Apeiron rotor, fixed tools with tungsten coating and rotor with steel profiles.**

### Dotazione standard

- Telaio costruito interamente in acciaio DOMEX.
- Controtelaio interno in acciaio HARDOX con 2 controcotelli in acciaio mm 20 di spessore.
- Martinetto idraulico per apertura cofano.
- Valvola di massima ed anticavitazione.
- Tubi idraulici con raccorderia protetti da spirale (esclusi innesti terminali).
- Carter protezione motore.
- Motore idraulico bidirezionale a pistoni.
- Trasmissione a 5 cinghie trapezoidali.
- Slitte di appoggio con pattini anti-usura sostituibili.
- Protezione posteriore con catene ad alta resistenza a due file.
- Tubi con lunghezza 2,5 m.
- Rotore Apeiron.

### Accessori

- Kit valvola regolatrice in acciaio tarata completa di tubi di collegamento motore per portate fino a 280 litri con prioritaria a 190 litri • Sella d'attacco a disegno con perni Ø mm 70/80 - previo invio dati richiesti • Motore a pistoni VM 80 Bosh-Rexroth a cilindrata variabile • Piede di acciaio per appoggio escavatore • Kit valvola elettroidraulica completa di cavo elettrico di controllo del cilindro apertura sportello

### Standard

- DOMEX steel frame.
- HARDOX steel internal counter frame with 2 counter-knives 20 mm thick steel.
- Hydraulic jack for the housing opening.
- Pressure relief and anti-cavitation valve.
- Hydraulic pipes with fittings protected by a spiral (excluding terminal couplings).
- Motor protection shaft.
- Bi-directional hydraulic pistons motor.
- 5 trapezoidal belts ransmission.
- Adjustable skids with replaceable wear proof plates.
- Rear protection with high resistance two-rows chains.
- Pipes with length 2,5 m
- Apeiron rotor.

### Accessories

- Calibrated steel adjusting valve kit for capacities up to 280 litres with 190 litres priority valve • Dedicated attachment linkage pins Ø mm 70/80- please send the required data • VM 80 Bosch-Rexroth piston motor with variable displacement • Thumb bracket • Electro-hydraulic valve kit complete with electric cable to control the front hood opening cylinder











**Rotore Apeiron e con utensili fissi con inserti al tungsteno**  
**Apeiron rotor and with fixed tools and tungsten carbide inserts with steel profiles**

**HARDOX®** WEAR PLATE **DOMEX®** HIGH STRENGTH STEEL



### INFORMAZIONI TECNICHE - TECHNICAL DATA

Mod.									
	m (ft)	m (ft)	Ø mm (in)	Ø mm (in)	n.	kg *(lb)	lt (gal) min/max	Max. bar	n.
<b>THFP/A130</b>	1,30 (4.26)	1,65 (5.41)	273 (10.74)	500 (19.68)	5	1410 (3109)	170 ÷ 180 (37.39 ÷ 39.59)	330	26
<b>THFP/A160</b>	1,60 (5.24)	1,95 (6.39)	273 (10.74)	500 (19.68)	5	1600 (3527)	170 ÷ 180 (37.39 ÷ 39.59)	330	30

\* Attacco escluso / Linkage not included

### UTENSILI DA TAGLIO - CUTTING FLAILS

Con rotore dedicato With dedicated rotor	THFP/A 130	THFP/A 160		
	Nr. - No	Nr. - No	Ø cm	Ø in
Utensili fissi con inserti al carburo di tungsteno Fixed tools with tungsten carbide inserts	 26	30	40	15.74





**DECESPUGLIATRICE IDRAULICA PER TERNE E PALE ARTICOLATE**  
**HYDRAULIC FLAIL HEDGER MOWER FOR BACKHOE LOADERS**  
**AND ARTICULATED LOADERS**

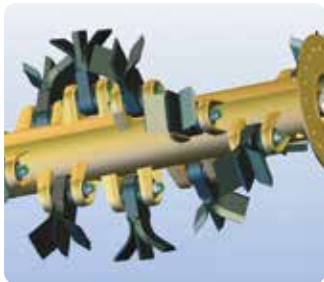

**Rotore con coltelli polivalenti e dritti.**

*Rotor with multi-use straight blades.*



Le decespugliatrici idrauliche serie TST50, sono particolarmente adatte ed indicate ai manutentori del verde comunale e stradale. Questo modello di decespugliatore idraulica offre un'ottima visibilità operativa essendo montata frontalmente alla trattore. La peculiarità di tale braccio è data dalla possibilità di chiudersi in maniera compatta a tutto vantaggio della visibilità dell'operatore anche durante i trasferimenti. Dotato di sicurezza idraulica sul secondo braccio, il modello TST50 si contraddistingue inoltre per essere provvisto di un dispositivo automatico antiribaltamento, oltre che di uno scambiatore di calore, che consente una maggiore efficienza operativa.

*The TST50 hydraulic reach mowers, were developed and designed especially for the municipal and ground care operators. This model is mounted to the front of the tractor which allows for excellent operational visibility. The design of the arm allows the operator to fold it in a compact way to allow greater visibility for the operator during transfers. Equipped with a hydraulic break back system on the second arm, the TST50 model is also equipped with an automatic anti-tilting device. The TST50 is also equipped with an oilcooler, which allows for greater operational efficiency.*



Pompa in ghisa ad ingranaggi.  
Gear pump.



Doppio effetto.  
Single acting - double acting automatic switch.











Accumulatori di azoto.  
Lift float nitrogen accumulator.



Dispositivo di sicurezza secondo braccio.  
Hydraulic breakaway on second arm with accumulator controlled autoreset facility.

## INFORMAZIONI TECNICHE - TECHNICAL DATA

Mod.	 m (ft)	 m (ft)	 m (ft)	 m (ft)	 kg *(lb)	 lt (gal) min/max	 Max. bar	 n.	 n.
<b>TST50</b>	1,20 (3.94)	5,04 (16.54)	4,93 (16.17)	2,95 (9.68)	920 (2028)	80 ÷ 100 (17.60 ÷ 21.99)	220	44	60

## POSIZIONI DI LAVORO - WORKING POSITIONS

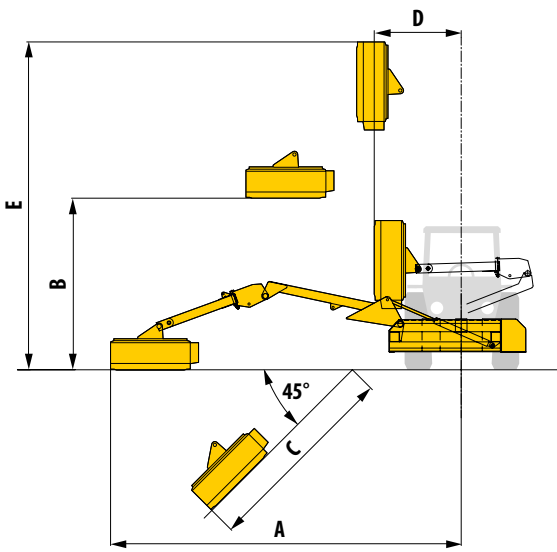
	TST50	
	m	ft
A	5,04	16.54
B	2,37	7.78
C	2,95	9.68
D	2,21	7.25
E	4,93	16.17

## TESTATA TRINCIANTE - FLAILHEADS

TI 120  
Trasmissione diretta  
Direct drive motor



Modello Model		
	Kg	lbs
<b>TI 120</b>	210	463

## UTENSILI DA TAGLIO - CUTTING FLAILS

Con rotore dedicato  
With dedicated rotor

Coltelli a "Y" per: erba, arbusti, cespugli, canne, legna  
"Y" flails for: grass, shrubs, bushes, reeds and wood



TST50  
Nr. - No



Ø cm

Ø in

44

3

1.18

Con rotore dedicato  
With dedicated rotor

Coltelli snodati per: erba, cespugli  
Articulated "Y" flails for: grass, reeds, bushes



60

2

0.79

## Dotazione standard

- Attacco universale a 3 punti ISO di 2 cat.
- Piastra forata per attacco contropiastra anteriore.
- Impianto idraulico ad ingranaggi ad alta potenza.
- Consolle comando elettrico a doppia velocità (DS-TRONIC DUAL).
- Ammortizzatore idraulico sul secondo braccio con ritorno automatico con accumulatore di azoto.
- Dispositivo floating (autolivellamento al terreno della testata trinciante).
- Floating verticale elettrico (sospensione 1° braccio mediante accumulatore di azoto (LFA elettrico)).
- Dispositivo antibalzo automatico ad azionamento elettrico (SAB).
- 2 piedi di supporto.
- Protezioni antifortunistiche «CE».
- Testata trinciante TI 120 con motore idraulico in ghisa con supporto in acciaio.

## Standard

- 3 point ISO universal linkage CAT 2.
- Drilled plate for fitting front counter-plate
- High Power Gear hydraulic system.
- Internal counter frame with counter-knives.
- Double-speed electric control (DS-TRONIC DUAL).
- Hydraulic breakaway with accumulator controlled autoreset facility on second arm.
- Floating head system to follow ground contours.
- Lift float electric (1st arm lift float with nitrogen accumulator) LFA Electric.
- Electric Roll Over protection system (SAB).
- 2 parking stands.
- Accident prevention protections according to EC directives.
- Flailhead TI120 with cast iron hydraulic motor with rear steel roller support

I dati tecnici riportati ed i modelli descritti si intendono non impegnativi. Per fini migliorativi il Costruttore si riserva il diritto di modifiche, senza preavviso.  
Disegni e fotografie possono riferirsi a equipaggiamenti opzionali o ad allestimenti destinati ad altri Paesi. Per ogni altra informazione, rivolgersi alla nostra rete di vendita.  
*The technical specifications indicated and models described are not binding. For the purpose of making improvements, the manufacturer reserves the right to make changes to them without prior notice.  
Drawings and photographs may refer to optional equipment or configurations intended for other countries. If you require further information, please contact our sales network.*



**FERRI**<sup>®</sup>  
SIMPLY. THE MOWER

**FERRI srl**

Via C. Govoni, 30 44034 TAMARA (Ferrara) Italy  
Tel. + 39 0532.866 866 - Fax + 39 0532.866 851  
info@ferrisrl.it

**www.ferrisrl.it**



Follow Us

