



FERRI[®]

SIMPLY. THE MOWER



AgriTeam



ZMTE PRO

PREVIEW



TRINCIATRICE LATERALE CON GRUPPO MOLTIPLICATORE ESTERNO

- Il nuovo modello di trinciatrice laterale ZMTE PRO, è la soluzione ideale per la pulizia di margini di appezzamenti, argini di fossi, ed in genere di aree verdi. Il posizionamento esterno alla trasmissione del gruppo moltiplicatore permette di operare totalmente all'esterno della carreggiata della trattore in assoluta sicurezza. Indicato per trattori dai 60 ai 80 HP. Di serie, il modello ZMTE PRO è fornito del controtelaio in DOMEX per evitare danneggiamenti della telaio stesso e dell'innovativo ammortizzatore meccanico a tutela dell'intera macchina in caso di urto contro ostacoli. Consigliato per erba, cespugli, sarmenti, arbusti e legna fino a 4 cm di diametro.

CENTRAL AND OFFSET MOWERS WITH EXTERNAL GEARBOX

- *The new model of side shredder ZMTE PRO, is the ideal solution for the cleaning of edges of plots of land, ditch banks, and generally green areas. The external positioning of the multiplier unit allows to operate totally outside the tractor track in absolute safety, suitable for tractors from 60 to 80 HP. As standard, the ZMTE PRO model is equipped with the DOMEX subframe to avoid damage to the frame itself and the innovative mechanical shock absorber to protect the whole machine in case of impact against obstacles. Recommended for grass, bushes, shrubs and wood up to 4 cm in diameter.*

FERRI
SIMPLY. THE MOWER

ZMTE
PRO

**TRINCIATRICI LATERALI
CON GRUPPO MOLTIPLICATORE ESTERNO
CENTRAL AND OFFSET MOWERS
WITH EXTERNAL GEARBOX**



Gruppo moltiplicatore esterno alla trasmissione. Gearbox external to the drive housing.

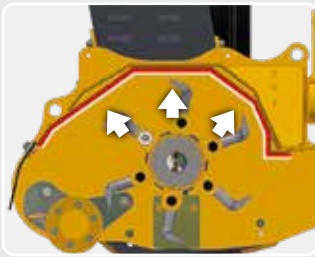

Controtelaio "Full coverage" in Domex 700. Inner lining "Full coverage" Domex 700 Steel.



Dispositivo ammortizzatore meccanico (salvaguardia in caso di ostacoli). Mechanical shock absorber device (protection in case of obstacles).



Telaio corpo trinciante flottante, auto-livellamento al terreno. Floating flail body frame, self-leveling to the ground.

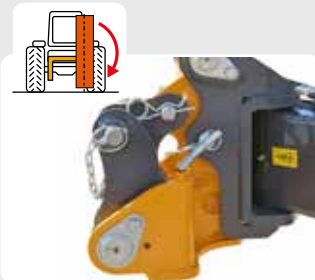



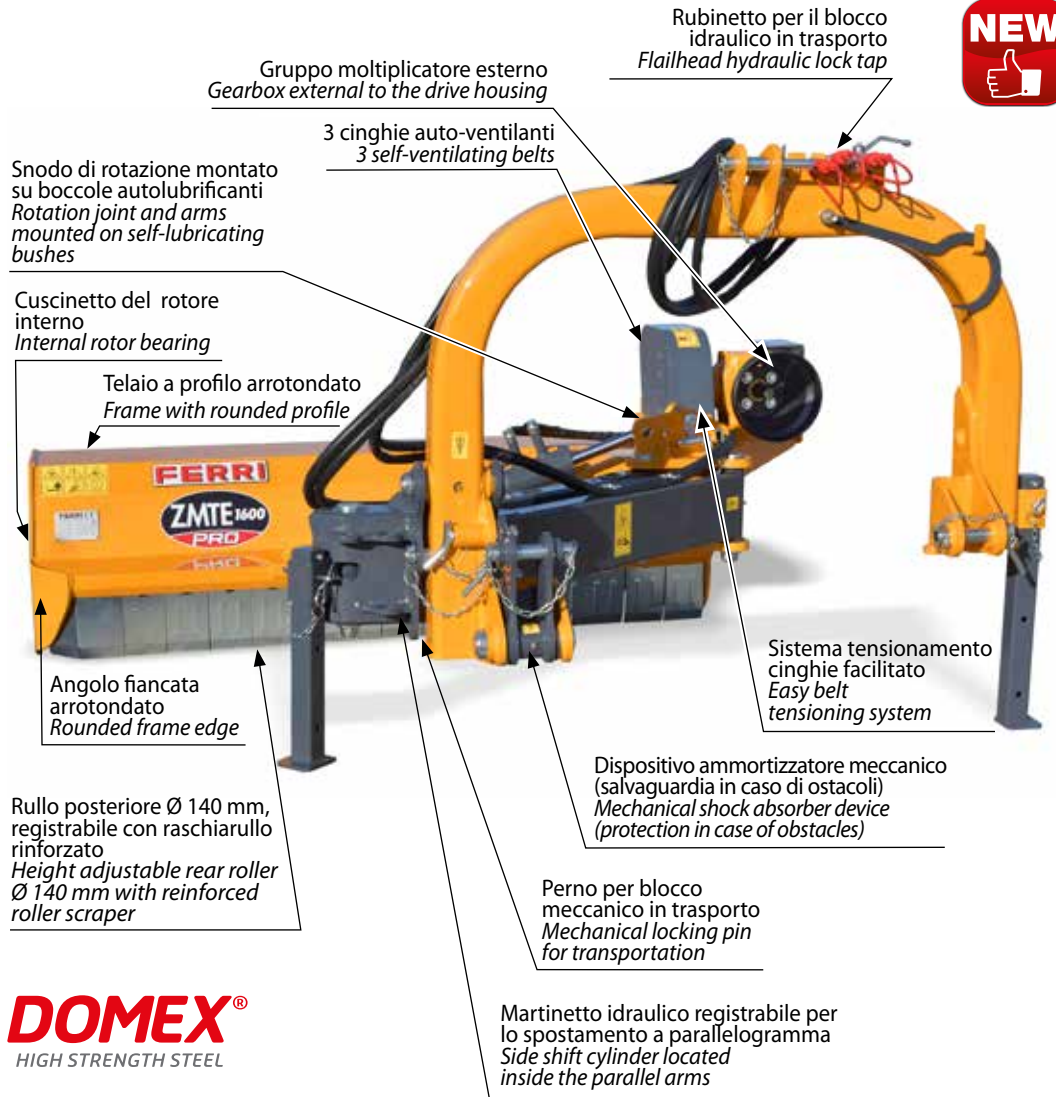

Perno per blocco meccanico in trasporto, (no catene, no staffe). Mechanical locking pin for transportation, (no chains, no brackets).

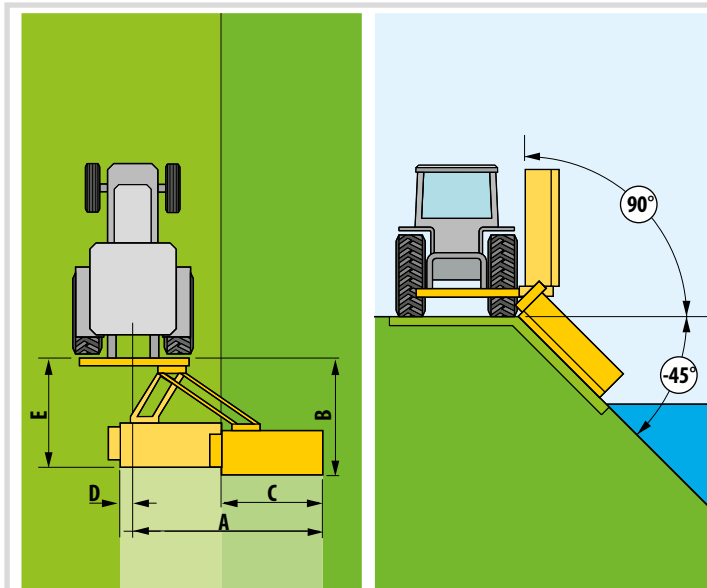





DOMEX[®]
HIGH STRENGTH STEEL



	ZMTE PRO 1600	ZMTE PRO 1800	ZMTE PRO 2000
	m	m	m
	ft	ft	ft
A	2,80 9,19	3,00 9,84	3,20 10,50
B	1,97 6,46	1,97 6,46	1,97 6,46
C	1,64 5,38	1,84 6,04	2,04 6,69
D	0,22 0,72	0,22 0,72	0,22 0,72
E	1,86 6,10	1,86 6,10	1,86 6,10

Modello Model								
	mm	ft	min HP	max kW	m	ft	kg	lb
ZMTE PRO 1600	1,64	5.38	60-80	45-52	1,80	5.90	2.400	5.291
ZMTE PRO 1800	1,84	6.04	60-80	45-52	2,00	6.56	2.400	5.291
ZMTE PRO 2000	2,04	6.69	70-80	52-59	2,20	7.22	2.600	5.732



INFORMAZIONI TECNICHE / TECHNICAL DATA

Modello Model							
	rpm	rpm	n	m/sec	ft/sec	Kg	lb
ZMTE PRO 1600	540	2.514	3	53,9	176,8	606	1.336
ZMTE PRO 1800	540	2.514	3	53,9	176,8	634	1.398
ZMTE PRO 2000	540	2.514	3	53,9	176,8	655	1.444

NR. UTENSILI / NO. FLAILS

Codice Code	Descrizione Description	Nr. Utensili No. Flails
ZF161ROA001	ZMTE PRO 1600 con coltelli "Y" / ZMTE PRO 1600 with "Y" flails	40
ZF161ROD001	ZMTE PRO 1600 con mazze stampate / ZMTE PRO 1600 with drop forged hammers	20
ZF181ROA001	ZMTE PRO 1800 con coltelli "Y" / ZMTE PRO 1800 with "Y" flails	48
ZF181ROD001	ZMTE PRO 1800 con mazze stampate / ZMTE PRO 1800 with drop forged hammers	24
ZF201ROA001	ZMET PRO 2000 con coltelli "Y" / ZMTE PRO 2000 with "Y" flails	48
ZF201ROD001	ZMTE PRO 2000 con mazze stampate / ZMTE PRO 2000 with drop forged hammers	24

UTENSILI DA TAGLIO / CUTTING FLAILS

Descrizione / Description	Tipo/Type	Ø cm		Ø in
Intercambiabili sullo stesso rotore / Interchangeable on the same rotor				
Coltelli a "Y" per: erba, cespugli, arbusti "Y" flails for: grass, bushes, shrubs		3		1.18
Mazze stampate per: legna, erba, sarmenti Drop forged hammers for: wood, grass, twigs		4		1.57

La trattoria deve essere dotata di almeno due prese d'olio a doppio effetto. In caso di disponibilità di una unica presa d'olio, si rende necessario montare il kit distributore a due leve (vedi accessori con supplemento prezzo). Il collegamento alla trattoria e la relativa messa in campo è CONSIGLIABILE siano effettuati insieme al Concessionario seguendo le indicazioni e le avvertenze indicate nel nostro libretto uso e manutenzione. Per eventuali altre informazioni contattare il nostro servizio post-vendita.

The tractor must be equipped with at least two double acting oil inlets. If only one oil inlet is available, a two lever control valve kit has to be fitted (see accessories at additional cost). It is RECOMMENDED that you connect the equipment to the tractor and start it up for the first time together with your Dealer, following the instructions and paying attention to the warnings indicated in our use and maintenance manual. If you require further information, please contact our after-sales service.

DOTAZIONE STANDARD

- Attacco universale a 3 punti ISO di 2° cat.
- Gruppo moltiplicatore pdf 540 giri/min in posizione ESTERNA al corpo macchina con ruota libera, **supporto scatola avvitato al telaio.**
- **Controtelaio "Full coverage" in Domex 700.**
- Cuscinetti rotore interni al telaio.
- Martinetto idraulico per inclinazione del corpo trinciante.
- **Spostamento laterale a parallelogramma con martinetto idraulico registrabile protetto.**
- Snodo di rotazione e bracci parallelogramma montati su boccole autolubrificanti.
- **Telaio corpo trinciante flottante, auto-livellamento al terreno.**
- **Dispositivo ammortizzatore meccanico (salvaguardia in caso di ostacoli).**
- Sicurezza meccanica in posizione di trasporto.
- Sistema tensionamento cinghie facilitato.
- FerriPERFECT, processo di bilanciatura elettronica a controllo numerico a due fasi del rotore.
- Rotore "OVERLAP" con sviluppo elicoidale a doppia elica potenziato.
- Rullo posteriore Ø 140 mm, registrabile con raschiarullo rinforzato.
- Protezione anteriore con bandelle in acciaio.
- Protezione posteriore in gomma-tela antiabrasione rinforzata.
- **Albero cardanico a profilo esalobato con crociere rinforzate.**
- Imballo su pallet dedicato.
- Protezioni antifortunistiche «CE».

STANDARD EQUIPEMENT

- *Universal three point linkage ISO cat. 2.*
- *Gear unit pdf 540 rpm in OFFSET position, box support bolted to the frame.*
- **Inner lining "Full coverage" Domex 700.**
- *Internal rotor bearings.*
- *Head positioning hydraulic cylinder and mechanical safety device for transport.*
- **Lateral parallelogram offset with protected adjustable hydraulic cylinder.**
- *Rotation joint and arms mounted on self-lubricating bushes.*
- **Floating flail body frame, self-leveling to the ground.**
- **Mechanical shock absorber device (protection in case of obstacles).**
- *Transport position with mechanical safety device.*
- *Easy belt tensioning system.*
- *FerriPERFECT, electronic balancing system and two-phase numerical control of the rotor.*
- *Reinforced "OVERLAP" double row spiral rotor.*
- *Height adjustable rear roller Ø 140 mm. with reinforced roller scraper.*
- *Front guard with steel flaps.*
- *Rear guard with reinforced wear resistant rubber cloth.*
- **Hexalobate profile PTO shaft with reinforced cruises.**
- *Packaged on a separate pallet.*
- *Accident prevention protections according to EC directives.*

I dati tecnici riportati ed i modelli descritti si intendono non impegnativi. Per fini migliorativi il Costruttore si riserva il diritto di modifiche, senza preavviso. Disegni e fotografie possono riferirsi a equipaggiamenti opzionali o ad allestimenti destinati ad altri Paesi. Per ogni altra informazione, rivolgersi alla nostra rete di vendita.

The technical specifications indicated and models described are not binding. For the purpose of making improvements, the manufacturer reserves the right to make changes to them without prior notice. Drawings and photographs may refer to optional equipment or configurations intended for other countries. If you require further information, please contact our sales network.

